

FUTURA[®]
GERMAN TECHNOLOGY



www.futura.co.id

(T) : 0761-33338 (E) : info@wirakencana.com (W) : www.wirakencana.com

MULTIPURPOSECHAIR



FTR 405

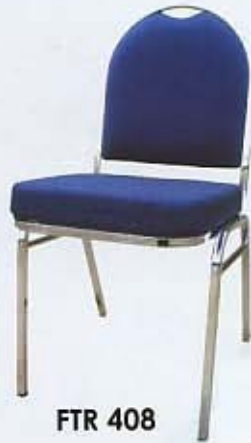

FTR 408



FTR 408 RE



FTR 457



FTR 458



FTR 419



FTR 409



FTR 418



FTR 410



FTR 432



FTR 435



FTR 475



FTR 406



FTR 426



FTR 416



FTR 456



FTR 415



FTR 417



FTR 467



FTR 300 CH



FTR 200 CH



FTR 200 PC





FOLDING CHAIR



FTR 407



FTR 501



FTR 508



FTR 747



FTR AG



FTR 509



FTR 506



SWIVEL CHAIR



FTR 353 NF



FTR 353 NFK



MJ FTR 146



MJ FTR 148



MJ FTR 150



MJ FTR 149



MJ FTR 189

Fold Direction

- For type MJ FTR 146 & MJ FTR 148 :
On each wings^o, press both of table joint evenly with the table board, then fold inside^o. (and the table will change into square table)
- On the wider legs^o press the locking bar outward^o, then fold inside.
- On the other legs^o press the locking bar outward^o, then fold inside.



Cara melipat Meja & Kaki :

- Untuk tipe MJ FTR 146 & MJ FTR 148 :
Tekan engsel-sengsel meja di bawah meja^o secara bersamaan hingga rata dengan papan meja, diikuti dengan melipat sisi-sisi papan mejanya ke dalam^o. (meja berubah menjadi bentuk kotak).
- Tekan pengunci kaki lebar^o ke arah luar, kemudian kaki lebar^o dilipat ke dalam.
- Tekan pipa pengunci kaki sisi yang lain^o ke arah luar, kemudian kaki^o dilipat kedalam.

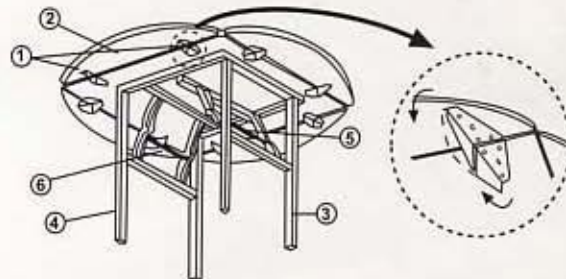

Specification

| | |
|-----------|--|
| Frame | MJ 146 / 148 / 150 / 149 / 189 |
| Material | Square \square = 1,2 30 x 30mm |
| Finishing | Powder Coating Black <input checked="" type="checkbox"/> |

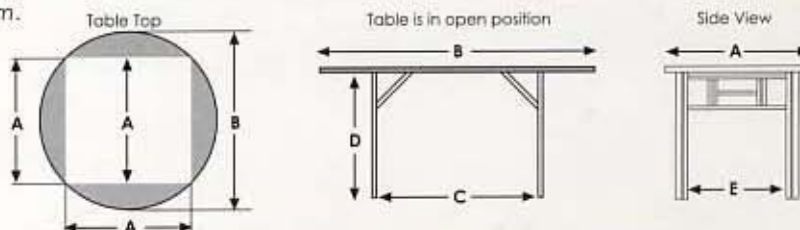

| Table Top | MJ FTR 146 | MJ FTR 148 / MJ FTR 150 | MJ FTR 149 | MJ FTR 189 |
|---------------|--|--|--|--|
| Material | 1. multiplex table ; t = 18 mm 2. laminating HPL ; t = 0.8 mm 3. list T. PVC = 19 mm | 1. multiplex table ; t = 18 mm 2. laminating HPL ; t = 0.8 mm 3. list T. PVC = 19 mm | 1. multiplex table ; t = 18 mm 2. laminating HPL ; t = 0.8 mm 3. list T. PVC = 19 mm | 1. multiplex table ; t = 18 mm 2. laminating HPL ; t = 0.8 mm 3. list T. PVC = 19 mm |
| Color | Grey | White | Grey | White |
| Ideal for use | Max. 6 person | Max. 8 person | Max. 4 person | Max. 6 person |

| Code | MJ FTR 146 | MJ FTR 148 / MJ FTR 150 | MJ FTR 149 | MJ FTR 189 |
|------|-----------------------|---------------------------------|------------|------------|
| A | 870 mm | 1020 mm | 760 mm | 600 mm |
| B | \varnothing 1200 mm | \varnothing 1400 mm / 1500 mm | 1150 mm | 1800 mm |
| C | 520 mm | 620 mm | 470 mm | 1180 mm |
| D | 760 mm | 760 mm | 760 mm | 760 mm |
| E | 530 mm | 600 mm | 470 mm | 480 mm |

100 x 50 76
Special orders in any different sizes are welcome
Melayani permintaan ukuran khusus



SCHOOL FURNITURE

K-Style



MJ FTR 606



MJ FTR 607



MJ FTR 617



KS FTR 106



KS FTR 107

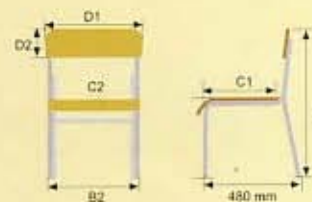
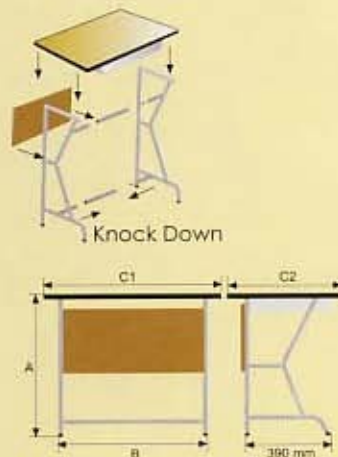

Stackable

Specification (Chair)

- Frame Material** : Steel Pipe \varnothing 22,2 x 1,4 mm
- Frame Finishing** : Powder Coating Ivory
- Seat and Back Material** : Plywood 1. 10 mm

Specification (Desk) K-Style

- Frame Material** : Steel pipe \varnothing 25,4 x 1,2 mm
- Frame Finishing** : Powder coating Ivory
- Table Top** : Plywood 1. 18mm
- Drawer** : Plate

Dimension (Desk)

| Information Product | TYPE | |
|------------------------|--------------|--------------|
| | MJ FTR 606 | MJ FTR 607 |
| A. Height | 670 mm | 750 mm |
| B. Width | 520 mm | 520 mm |
| C. Table Top (C1 x C2) | 600 x 400 mm | 700 x 500 mm |
| D. Student's range | 120 - 155 cm | 157 - 182 cm |

Dimension (Chair)

| Information Product | TYPE | |
|-------------------------|--------------|--------------|
| | KS FTR 106 | KS FTR 107 |
| A. Height | 700 mm | 770 mm |
| B. Width | 360 mm | 380 mm |
| C. Seat (C1 x C2) | 350 x 345 mm | 360 x 385 mm |
| D. Back width (D1 x D2) | 365 x 150 mm | 385 x 150 mm |
| E. Student's range | 120 - 155 cm | 157 - 182 cm |



- Rounded tip to ensure safety, especially to children.
- Ujung meja oval, sehingga tak membahayakan anak-anak anda.



- Easily packed, suitable for outdoor activities
- Mudah dikemas dan dibawa, cocok untuk acara rekreasi keluarga.



- Can be use as white board and easily wiped out
- Dapat digunakan untuk menulis, mudah dihapus.



- Strong & comfort, can also be used for adults.
- Kuat, aman & nyaman. Bisa digunakan bagi orang dewasa.

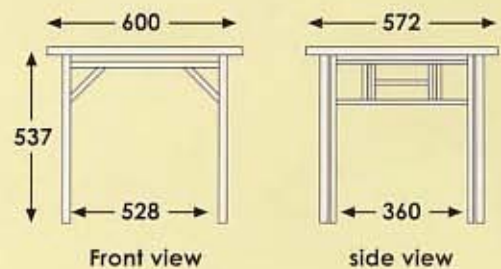
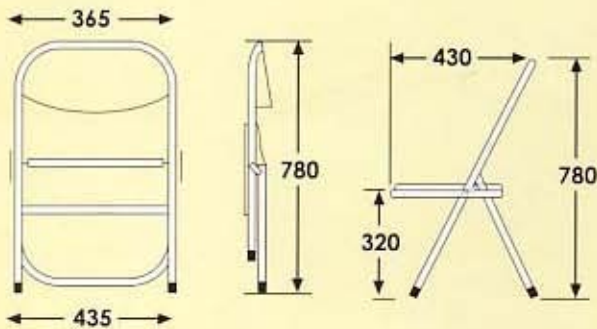

Specification (Chair)

- Frame** : Round pipe, back leg "U" shape
- Finishing** : Nickel Chrome Plating 12 Micron
- Netto Weight/Pc** : 3,8 kg
- Packing** : 1 Carton contain 6 pcs (24,2 kg)
- Dimension** : 445 mm x 285 mm x 780 mm

Specification (Table)

- Frame** : Square pipe 30 x 30 mm
- Finishing** : Powder Coating
- Table Top** : MDF
- Netto Weight/Pc** : 12 kg
- Packing** : 1 carton contain 2 pcs (25 kg)
- Dimension** : 610 mm x 260 mm x 580 mm



Ironing Board & Steps FORRESTER



Ironing Board featuring :

- Safe iron hopper.
Meja setrika yang aman.
- Durable scorch resistant thick cushioning.
Bantalan tebal tahan panas.
- Ventilated top permeating maximum steam.
Permukaan berventilasi untuk penguapan maksimum.

Step Ladder featuring :

- Vigorous lightweight ladder for lasting use.
Tangga yang kokoh dan tahan lama.
- Additional 64 cm height provided in 3 steps. *note*
Ketinggian tangga 64 cm dengan 3 pijakan.
- Solid platform to stand on save for everyone.
Tatakan pijakan yang kokoh aman untuk setiap orang.
- Automatic locking securing extra safety. ✓
Penguncian otomatis untuk keamanan extra.
- Non-slippery feet.
Kaki tidak licin.
- Safe to carry weight up to 150 kg. ✓
Aman menanggung beban sampai 150 kg.



Small space 129 x 37 x 12 cm
Cardboard box 130 x 38 x 13 cm

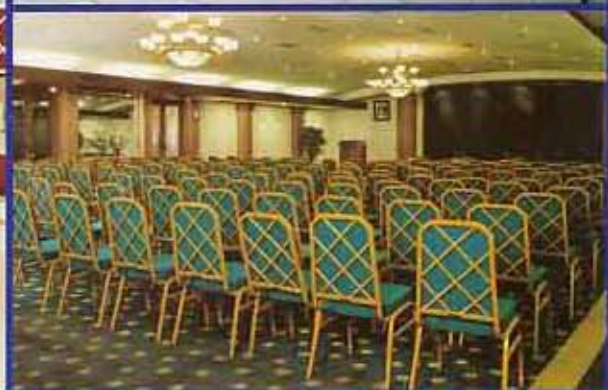

THE GUARANTEE OF ORIGINALITY QUALITY PRODUCT

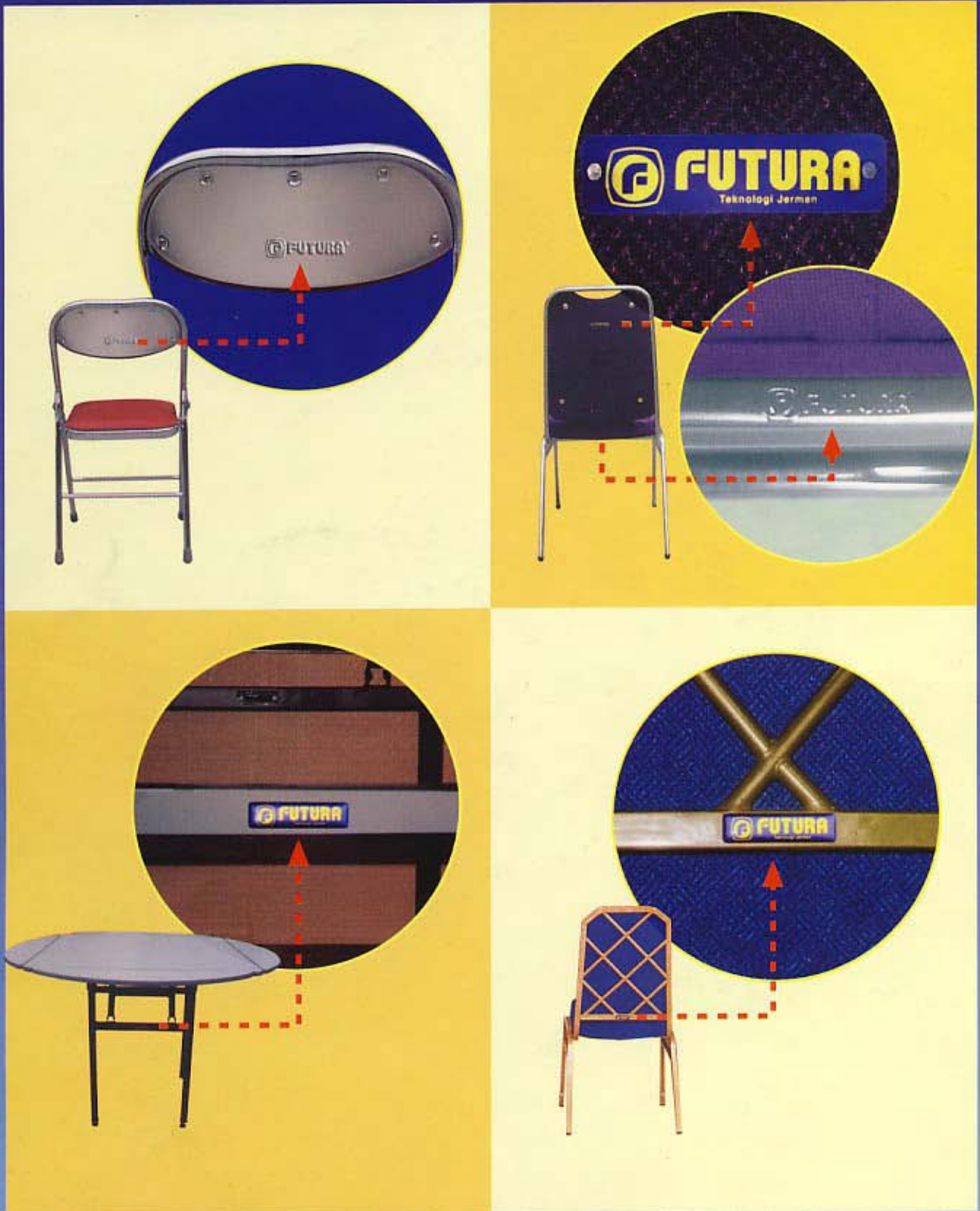

Kenali dengan pasti produk asli kualitas bergaransi